



SOUTDOOR 900

Dual Technology wireless outdoor Detector

INSTALLATION
V1.0

ENGLISH

1. INTRODUCTION

Soutdoor 900 is bidirectional wireless outdoor sensor.

It can be used with all types radio receivers of the series 900, and for low consumption 12uA, ensures a long battery life. It a full digital sensor (with digital PIR), with an analysis system devoid of the classical noise that occur with the use of traditional analog PIR. By using full digital PIR, the device is immune from white light masking and has much higher efficiency in the discrimination in its action range. Even with the significant temperature variations, the digital temperature compensation system, guarantees a high efficiency. It has a range of 15m, with an opening angle of 90 °.

Characteristics:

- *Dual technology outdoor sensors (2 digital PIR with 4 seconds AND operation).*
- *Different types of lenses depending on the type of installation (volumetric; vertical/horizontal).*
- *PET immune.*
- *Back tamper and anti-opening tamper.*
- *Range adjustable from 3 meters to 15 meters via wireless*
- *Walking test led (via wireless)*
- *Buzzer alarm (via wireless)*
- *Test function (via wireless)*
- *Double pulse (via wireless)*
- *Bracket*

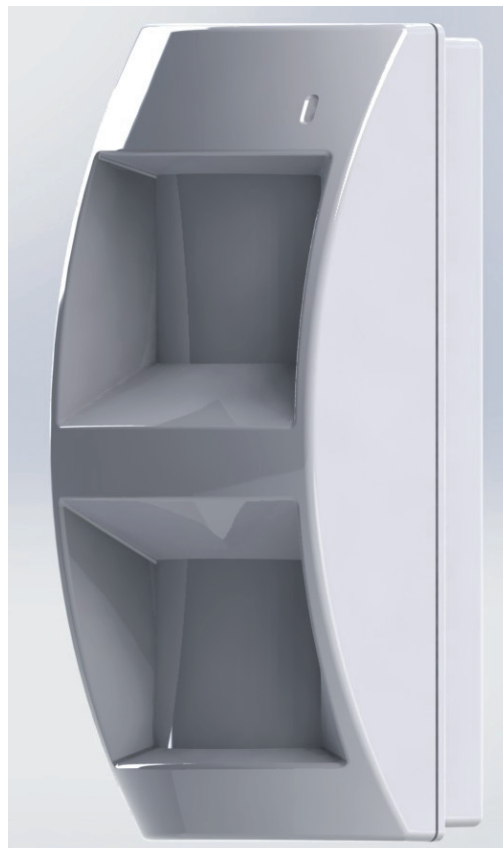

BOARD DESCRIPTION

BATTERY	1/2AA 3.6V
TAMPER	back tamper and antiopening tamper
LED	Walk Test led
Buzzer	Alarm Buzzer
Range	from 3 to 15m
2 pulses	enable via wireless

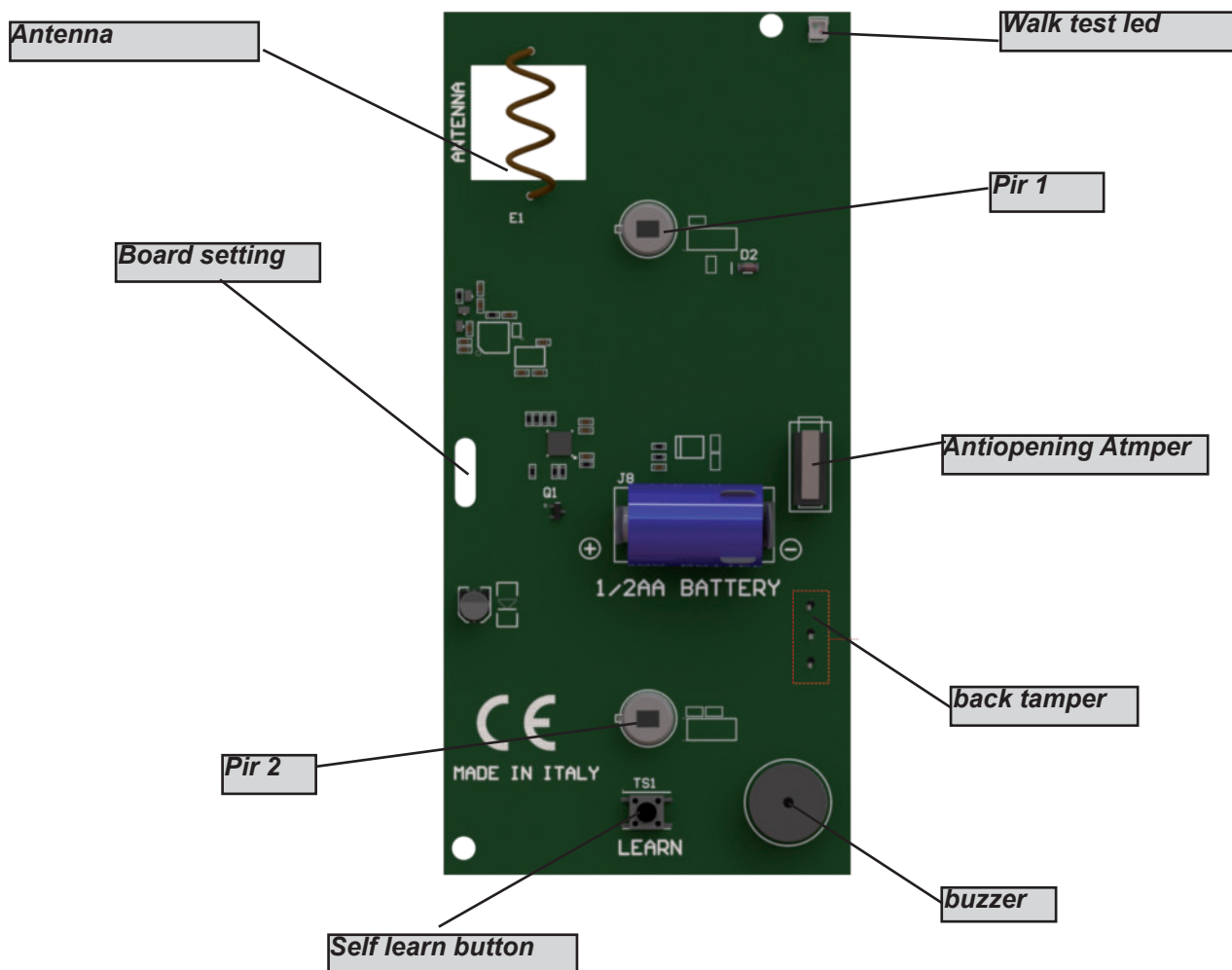

Board Adjustment

In addition to the electronic adjustments, the sensor can be vertically adjusted physically regarding the direction of the beams. As you can see in the picture below you can slide the board inside the cover.

The sliding is opposite to the beam so when the board is moved upward the beams are lowered and when it is lowered beams are raised.

In the figures below you can see the effect achieved when moving the board. These adjustments are also needed for animal tolerance.

With the lens mounted by default (volumetric up, horizontal curtain down) you can get a very accurate result on animal tolerance.

Test the sensor alarm threshold whenever an adjustment is made.

NOTE: sliding the board it must remain within ± 2 mm. from centrally located for not to compromise the sensor detection

Sliding system detail board

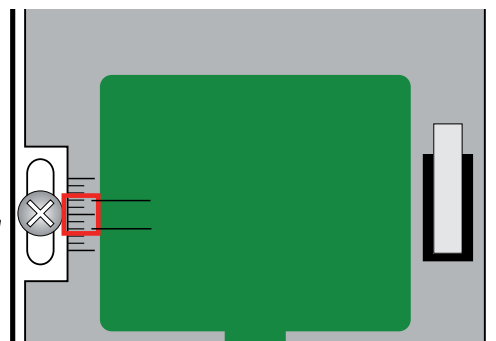

Coverage diagrams based on board position

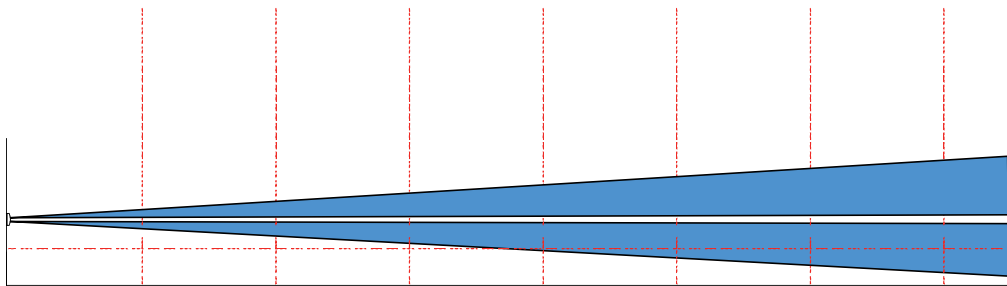
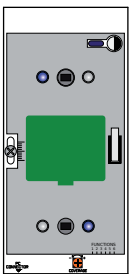
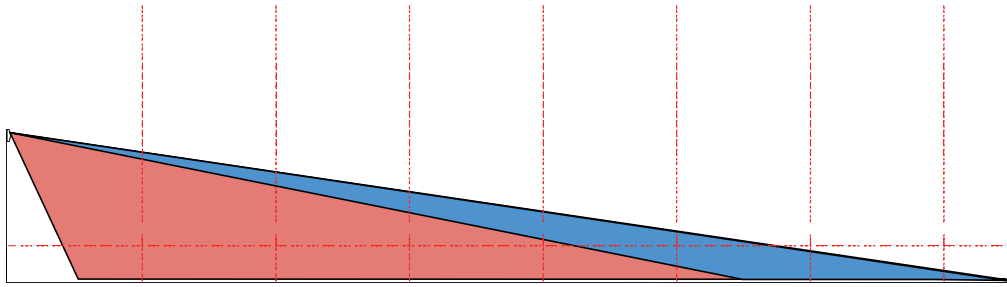
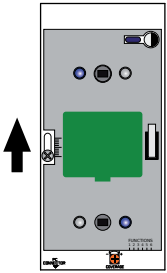
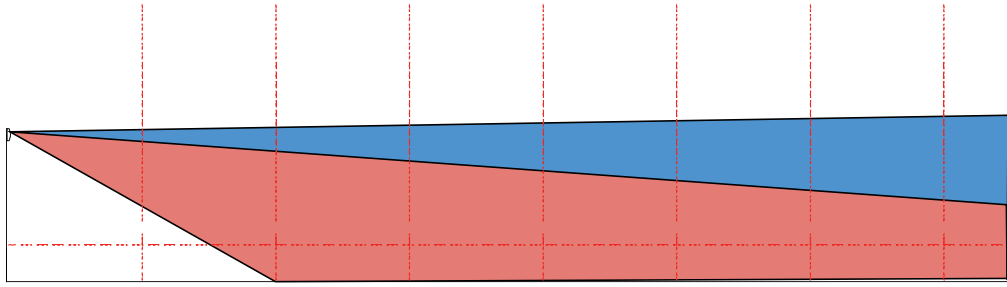
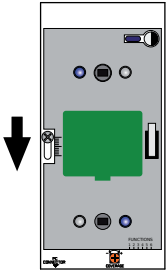
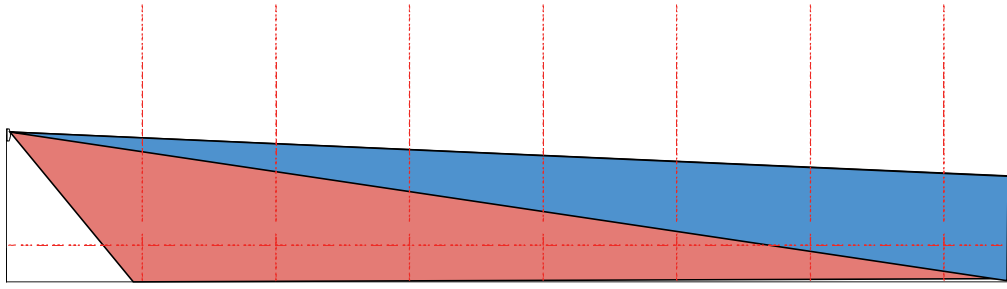
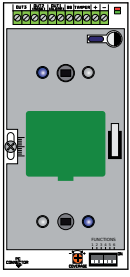

Note: the figures show the effect of the beams based on the position of the board. Since they are purely indicative, we recommend you thoroughly test the sensitivity of the sensor after each adjustment.

TYPE LENS - how to recognize them

In the sensor package there are 3 types of lenses:

- Horizontal curtain lens (Fig. 1)
- Vertical curtain lens (fig. 2)
- Volumetric curtain lens (fig. 3)

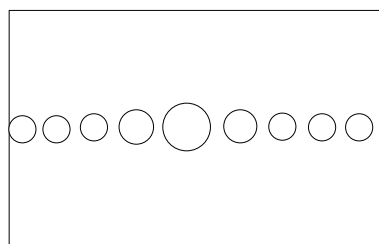
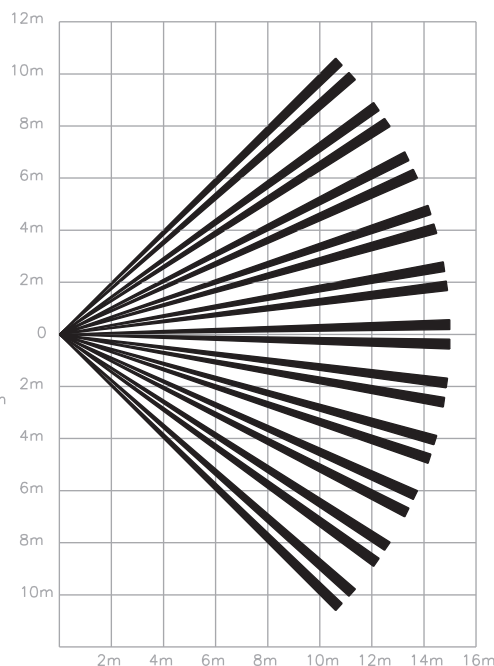
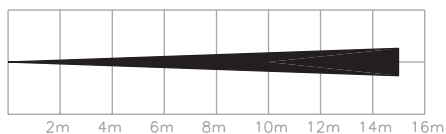

FIG. 1



On the sensors are mounted, by default, on the PIR1 (top) the volumetric lens and on the PIR2 (bottom) the horizontal curtain lens. In the next section it's explained how to use the different types of lenses.

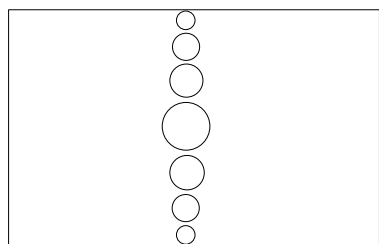

FIG. 2

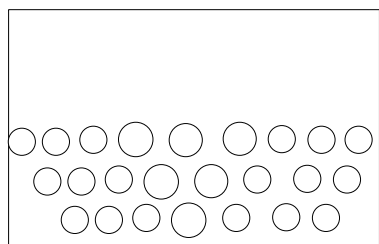
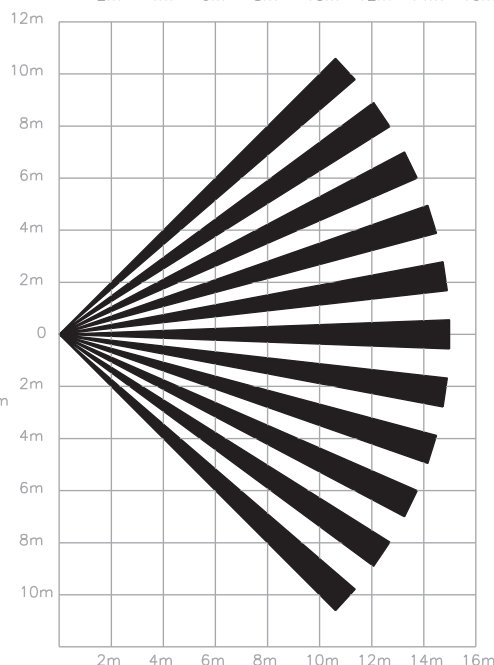
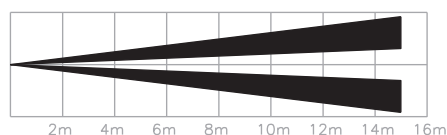
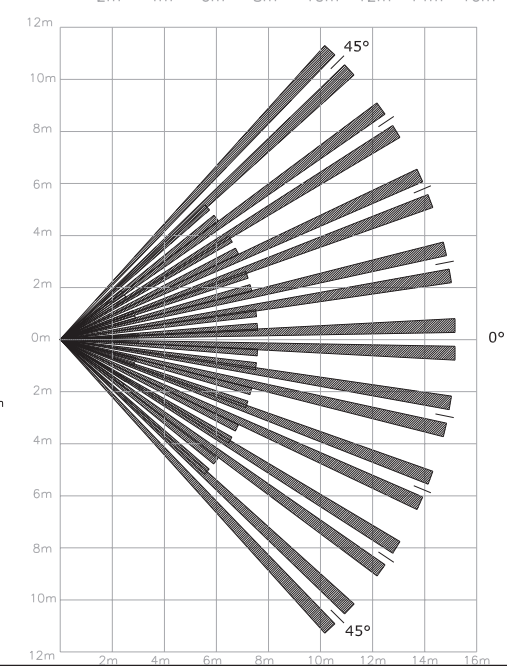
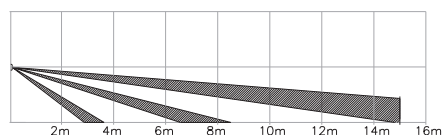

FIG. 3



Lenses provided

The lenses mounted on the sensor are: volumetric for PIR 1 (upper), horizontal curtain for PIR 2 with rather thick beams. This solution is designed for almost all applications that require a standard installation at about 1.8/2 meters high, with the possibility of managing the presence of animals. (fig. above)

Besides the standard configuration, you can use the optional lenses included in the package.

Using the sensor with 2 horizontal curtain lenses: you can position the sensor at a height between 80 cm and 1.2 m based on need. Then adjust the board position based on the beam range.

This way you have a variable height protection from 35/40 cm from the ground and up to 1.6 cm high with a horizontal coverage of about 80/100 degrees. With this configuration you can achieve immunity to medium to large animals even at considerable distances (15 m).

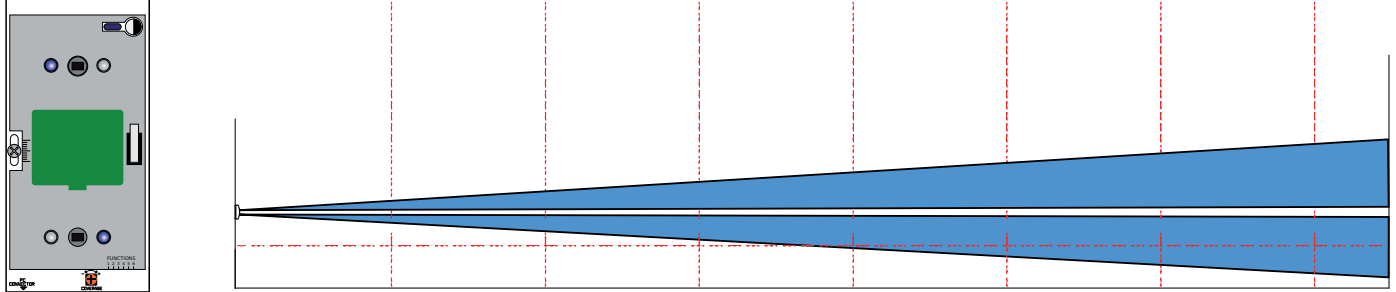

Using the sensor with 2 vertical curtain lenses: the use of vertical curtain lenses is based on the need to protect doors and windows with a vertical curtain that is no wider than 50 cm. In this way the protection is only near the doors and/or windows without extending into other areas. You can position the sensor at a height of between 1 m and 2 m based on need. The beam is about 50 cm wide for an aperture of about 90/100 vertical degrees (fig. below)

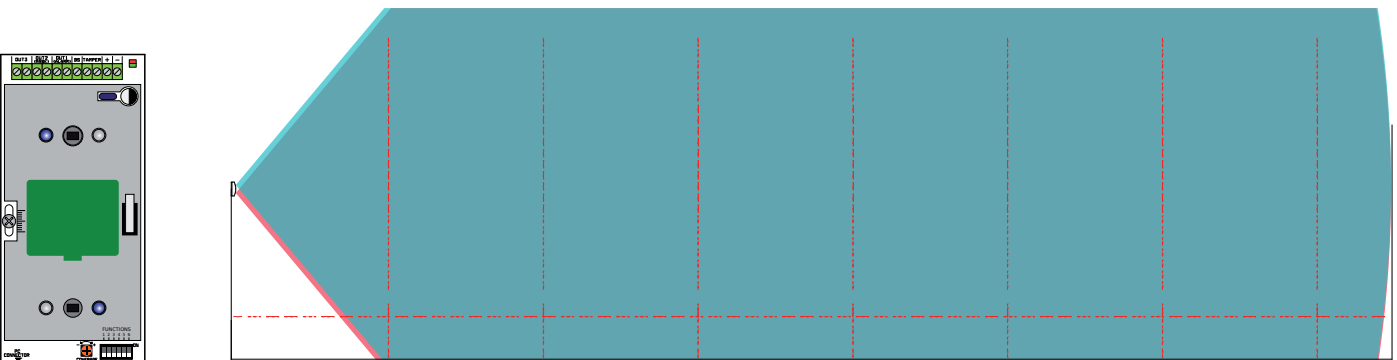

Replacing the lenses

The lenses are attached to the sensor with funnels that are snapped into the housings on the front cover (fig.)

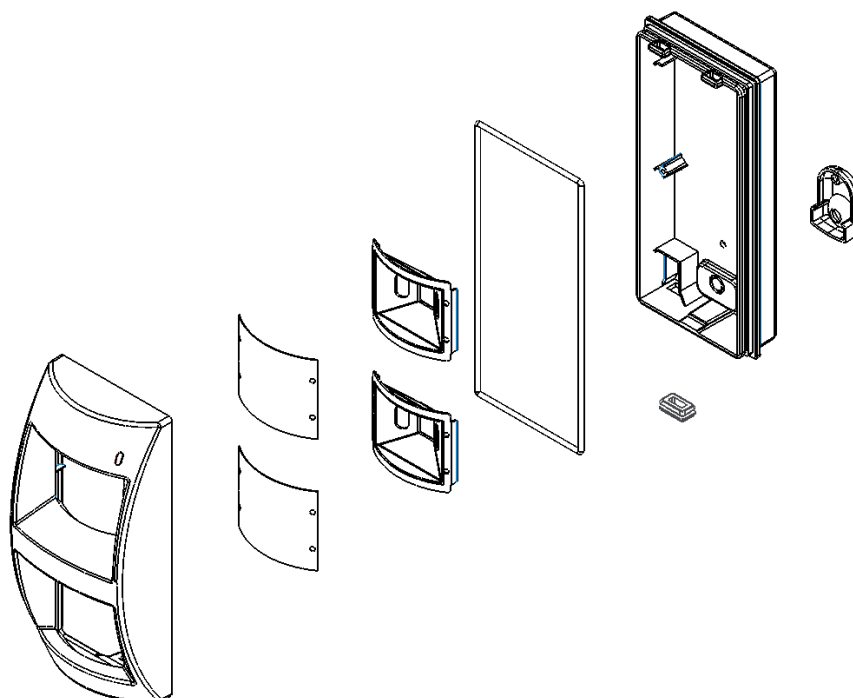

To replace the lenses you must remove the funnel and remove the lens that is resting in the housing as shown in figure 1 and 2.

Note: the smooth part of the lenses must be positioned towards the outside.

Important: the volumetric lens has one direction, therefore pay close attention to how it is positioned. When put up against the light you can see how the FRESNEL lenses work. They are always kept towards the bottom.

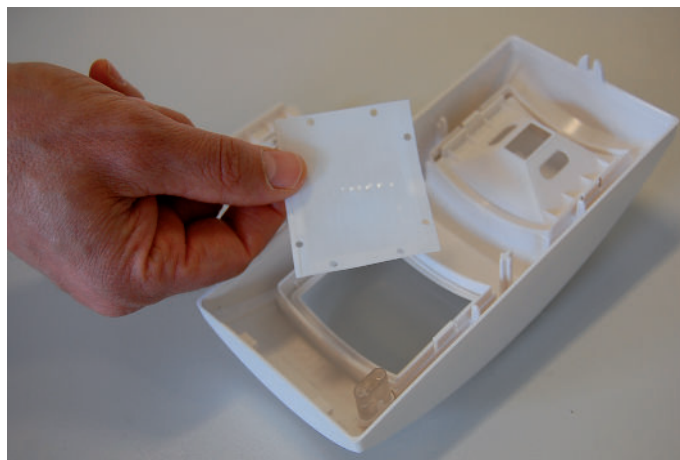

Position the new lens in the housing, replace the funnel and snap it into its housing.



2. INSTALLATION

Remove the screws from the upper cover and then remove the board mounting screws.



Remove the board, making a hole in the back of the upper cover for the cable to pass through in a suitable installation position. Make another 2 holes to attach the sensor to the wall. We recommend using anchors that are no smaller than 3 mm.



Screw for Anti-removal system - Fig.1

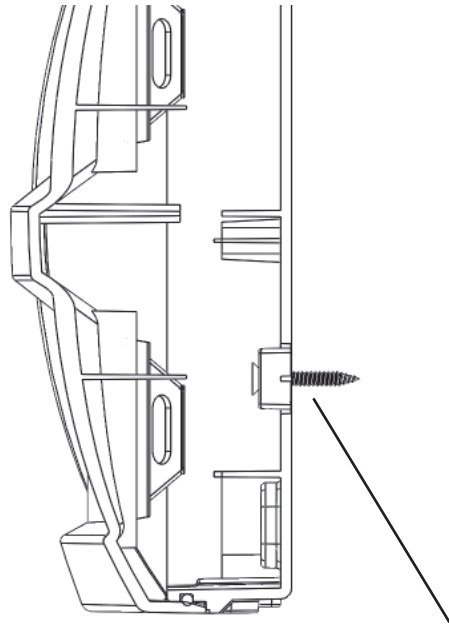

Screw for Anti-removal system - Fig.2

Once the cable and wall attachment holes have been made, take the measurement to attach an anchor (3 mm) to the anti-removal system. (see above fig.1 and fig.2)

Then attach the bottom and re-close, taking into account the positioning mentioned previously.

Note: remember that the distance between the board and the base is 13.5 mm. Space reserved for the proper positioning of the cable feeder or any piping to be inserted.

Using the bracket

You can use the bracket included in the package for attaching it to the wall. The back of the cover is ready for attachment of the bracket and for the passage of the cables inside it. You can see how it should be used in the figure. In case of use of the bracket, for the closure of the anti-removal tamper mount the specific screw, in the seat shown in Fig. 1.



bracket

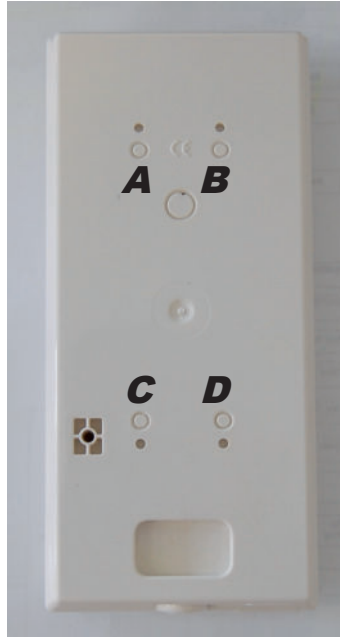

Bottom of the detector



Detector + bracket

TECHNICAL FEATURES

SOUTDOOR 800	
<i>Input Voltage</i>	<i>battaria 1/2AA 3.6V</i>
<i>Current Drain (Alarm / Stand-By)</i>	<i>12uA min. - 26mA max</i>
<i>Frequency</i>	<i>868.3 Mhz</i>
<i>Trasmission</i>	<i>FSK</i>
<i>Codify</i>	<i>128bit AES rolling code</i>
<i>Supervision</i>	✓
<i>Coverage</i>	<i>15mt</i>
<i>Angle</i>	<i>90°</i>
<i>2 PIR</i>	<i>digital</i>
<i>Lente 1</i>	<i>Fresnel (22 Patterns su 3 livelli)</i>
<i>Lente 2</i>	<i>Fresnel Horiz. curtain (11 Patterns 1 livello)</i>
<i>Lents Opzional</i>	<i>Fresnel vert. (11 Patterns 11 livelli)</i>
<i>IP Grade</i>	<i>IP 44</i>
<i>Antiopening</i>	✓
<i>Back tamper</i>	✓
<i>Operating Temperature</i>	<i>From -30 °C to +55 °C</i>
<i>Storage Temperature</i>	<i>From -30°C to +60 °C</i>
<i>RFI Protection</i>	<i>30 V / m (80 /1000 MHz)</i>
<i>Walk Test LED</i>	✓
<i>Cover</i>	<i>ABS</i>
<i>Dimensioni</i>	<i>185 x 85 x 70 mm</i>
<i>Weight</i>	<i>265 gr.</i>



**Installation must be performed according to accepted standards by specialized personnel.
The manufacturer shall not be responsible if the product is tampered with by unauthorised persons.
We recommend that you check the correct operation of the alarm system at least once per month. A reliable electronic alarm system does not prevent intrusions, robberies, fires or other occurrences but simply reduces the risk of occurrence.**

**Installation must be carried out following the local installation norms by qualified personnel.
The manufacturer refuses any responsibility when changes or unauthorized repairs are made to the product/system.
It is recommended to test the operation of the alarm product/system at least once a month. Despite frequent testing and due to, but not limited to, any or all of the following: tampering, electrical or communication disruption or improper use, it is possible for the product/system to fail to prevent burglary, robbery, fire or otherwise. A properly installed and maintained alarm system can only reduce the risk that this happens.**