



COMPLIANT  
EN50131-2-4:2008



# SOUTDOOR / T

Triple Technology Outdoor Detector with Antimasking \*\*

INSTALLATION  
V1.3

## ENGLISH

### 1. INTRODUCTION

*SOUTDOOR is a multifunction detector, versatile and efficient, capable to minimize false detections. Through various adjustments and settings of presets you can satisfy any type of installation. IP protection ensures maximum durability and protection against the elements. The possibility of changing lenses of different types, makes SOUTDOOR particularly suited to all types of installation (grazing walls for the protection of doors and windows, in environments full of vegetation or in the presence of animals).*

#### **Characteristics:**

- *Triple technology outdoor sensors (2 pyroelectric, 1 microwave).*
- *Possibility to configure 8 operating PRESETS according to the installation requirements*
- *Different types of lenses depending on the type of installation (volumetric; vertical/horizontal).*
- *PET immune, adjustable with different weights.*
- *Double anti-masking (not certified IMQ Security System).*
- *Back tamper and anti-opening tamper with micro switches.*
- *Anti-rotation tamper with accelerometer in case the sensor is hub mounted.*
- *Automatic self test (analysis of the voltage supplied, sensor coverage)*
- *4 freely configurable output relays for alarm functions, masking, blinding.*
- *System status notification input for event LOG activation*
- *Coverage adjustment trimmer in stand alone operation*
- *Bi-colour Red and Green LED*
- *6 Dip switches for setting up functions and presets*

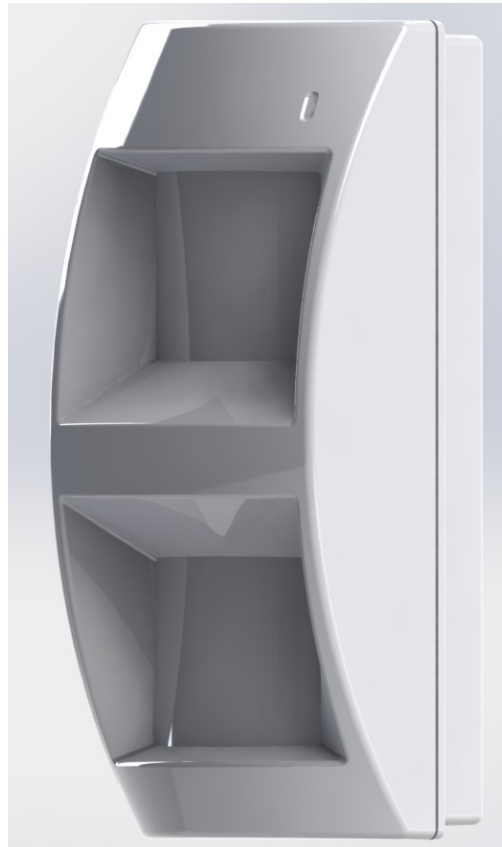

## DESCRIPTION OF THE CONTROL BOARD

<b>+/-</b>	Power supply 13.8 Vcc
<b>B/S</b>	necessary for the activation of walk test led
<b>TAMPER</b>	Tamper (N.C.) notification of opening of all anti-opening contacts and the accelerometer
<b>out 1 ALARM</b>	General alarm switch (NC)
<b>out 2 MASK</b>	Anti-masking line (NC)
<b>Out 3 diagnosis</b>	output for reporting errors in: power supply, sensors (the 2 PIR and microwave), and CPU
<b>Bi - colour LED</b>	green = microwave detection notification red + green = PIR detection notification red = alarm notification (alarm relay open)
<b>anti-opening switch</b>	front anti-opening and rear back tamper protection
<b>board height adjustment</b>	change coverage and animal immunity level (see explanation)
<b>Trimmer coverage</b>	Adjustment trimmer for general sensor coverage
<b>PC connector</b>	For PC software programming, an optional adapter is needed (S com)
<b>dip switches</b>	They are used to set the operating mode of the sensor (see details)

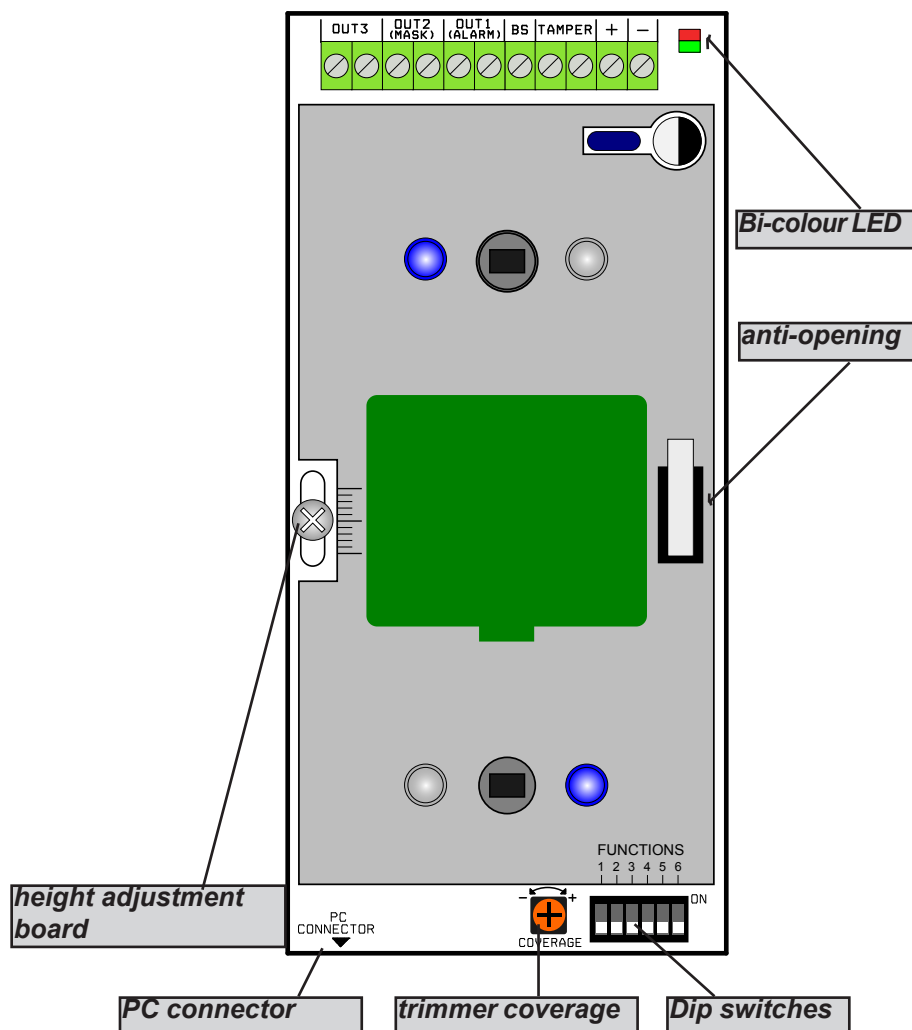

## OPERATIONAL DETAILS

### Outputs, B/S terminal

As previously described, the sensor outputs are all N.C. programmed and with the following functions:

**Out 1** = alarm output activated when the sensor reports an alarm regardless of the operating configurations adopted (AND - OR - AUTO OR etc.).

**Out 2** = notification of blinded sensor activated when one or more detectors are masked in some way to reduce or block intrusion detection.

**Out 3** = notification of functional diagnosis of the sensor, activated when there is a problem with the power supply (e.g., too low) or related to the operation of the 2 PIRs and MICROWAVE, or when the CPU of the sensor is not responding. This is checked once a day, and takes about 30".

**Out 4** Output = sensor anti-opening and anti-tampering notification, activated when one of the two switches is opened, or when the motion sensor reports tampering.

Using the programming software you can change all the output associations. These can be combined freely to any function of the sensor (e.g., association to individual PIRs or MW in various ways)

**Note:** The default association is EN 50131 compliant. Changes to this configuration could void conformity.

**B/S Terminal** = This terminal is used to notify the sensor when the panel is armed or not armed. Consequently, it activates the EVENT LOG and Walk Test led (if there is nothing connected to the B / S LED is always working). The connection between the control unit and sensor, requiring a resistor 1k as PULL UP, is to be connected to a positive and the B/S terminal. When it is brought to negative (e.g., from an OC output from alarm panel) it starts to log the events and manage the LED Wal Test, which will be switched on only when the system is armed.

**NOTE:** the event log is available via PC software, so it is also necessary to enable it to bring to ON the dip 5.

The dip 5 enables the sensor to work with a software connection with which you can view in real time the behavior of the 3 technologies. Even with Dip 5 to ON the settings are those by default with the scope of the trimmer halfway.

In order to change the set up of the detector, once you open the software and you are connected (DIP5 ON), it's necessary to make a transaction between ON and OFF of the DIP 1; at this point you can modify the settings of the detector.

**IMPORTANT:** After being disconnected, the detector will remain with the open session in "WRITE" mode for another 60 seconds. After that time, for change the parameters you will need to repeat the steps described above.

To connect to the detector you need the software and the COM/S adapter.

### Adjustment trimmer for coverage

The coverage adjustment trimmer affects all 3 sensors (PIR 1 - PIR 2 - MW) so when you use it, you are adjusting the total coverage regardless of the type of configuration.

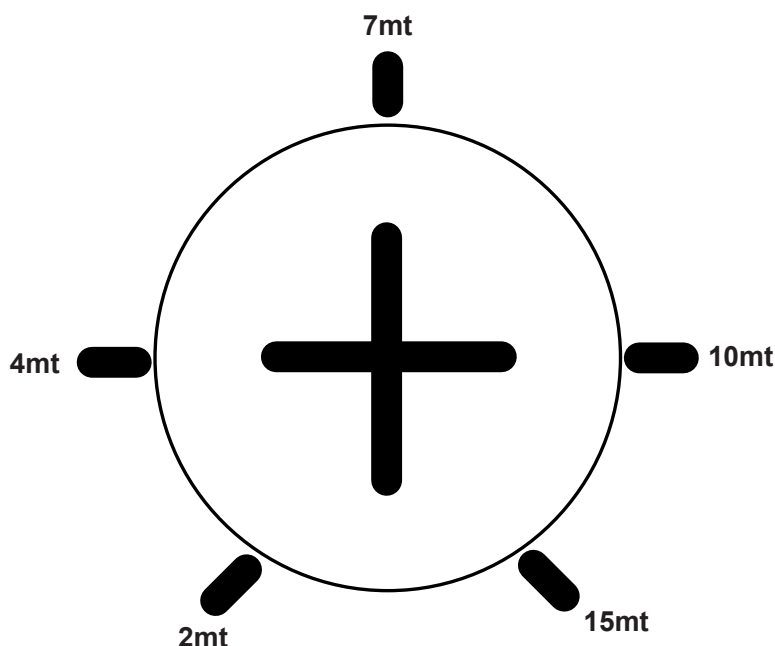

## Dip switches

The sensor has 6 dip-switch with which you can change the mode of operation.

The first 2 dip (1-2) are used to modify the setup depending on the lens used. The dip 3-4 are used to change the setup of operation of 2 PIR and microwave. The pins 5-6 respectively for control via PC and the LED alarm notification.

Dip 1	Dip 2	LENSES	Operation with different lenses (pir 1 high - pir 2 low)
off	off	PIR 1: VOLUMETRIC PIR 2: HORIZ.CURTAIN	Standard configuration, can be used at a height ranging from 1.60mt to 2.1mt depending on the position of the card inside the cover (see also BOARD ADJUSTMENT). This configuration allows installations of different types, with tolerances to animals of different size.
on	off	PIR 1: HORIZ.CURTAIN PIR 2: HORIZ.CURTAIN	Configuration to be used with the sensor at a height of between 80cm and 1.2mt. It's possible to obtain also in this case tolerances to animals of different size.
off	on	PIR 1: VOLUMETRIC PIR 2: VOLUMETRIC	Configuration more accurate in detecting but with low tolerance to the presence of animals. The fixing can be done from a height of 1.6mt to 2.1mt.
on	on	PIR 1: VERT.CURTAIN PIR 2: VERT.CURTAIN	Configuration used only with vertical curtain lens (see diagram below). It's used to protect windows and doors. Very low tolerance for animals.
Dip 3	Dip 4	SETUP	Description of operation
off	off	AND 3"	With this configuration, the sensor operates in AND mode (to give alarm is necessary that all 3 technologies are violated). The 3 seconds indicate the time window within which the 3 technologies must have violated.
on	off	OR	The sensor give alarm when one of the 3 technologies detects a violation.
off	on	AUTO OR	The sensor behaves normally in AND, but in case of repeated alarms from a single technology, it automatically goes in OR and breach notification.
on	on	AND 5"	The configuration AND to 5 seconds compared to 3" is particularly efficient against the detection of rapid movements, so it is to be used in the case of small animals, or for have a higher efficiency in revelation.
Dip 5	off	PC programming	With this dip-switch in off position all the sensor adjustments can be carried out through the trimmer and through dip-switches configuration. NOT ENABLE EVENT LOG FUNCTION
Dip 5	on	PC programming	When this function is set, all the settings of the sensor can be set via software. Once you have made the adjustment you can save them on the memory of the DEVICE. In this case it is also enabled in the event log, when the alarm system is armed (terminal B/S is NEGATIVE status)
Dip 6	off	Walk test led	Walk test led DISABLED
Dip 6	on	Walk test led	Walk test led ENABLED

## Board Adjustment

In addition to the electronic adjustments, the sensor can be vertically adjusted physically regarding the direction of the beams. As you can see in the picture below you can slide the board inside the cover.

The sliding is opposite to the beam so when the board is moved upward the beams are lowered and when it is lowered beams are raised.

In the figures below you can see the effect achieved when moving the board. These adjustments are also needed for animal tolerance.

With the lens mounted by default (volumetric up, horizontal curtain down) you can get a very accurate result on animal tolerance.

Test the sensor alarm threshold whenever an adjustment is made.

**NOTE:** sliding the board it must remain within  $\pm 2$  mm. from centrally located for not to compromise the sensor detection

Sliding system detail board

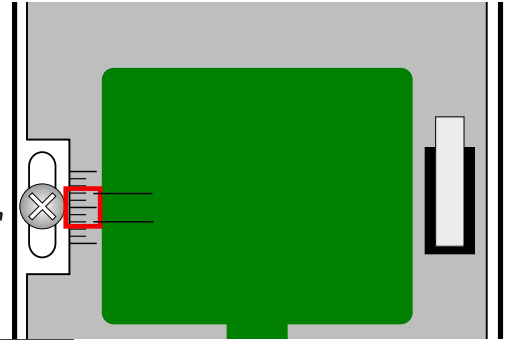

## Coverage diagrams based on board position

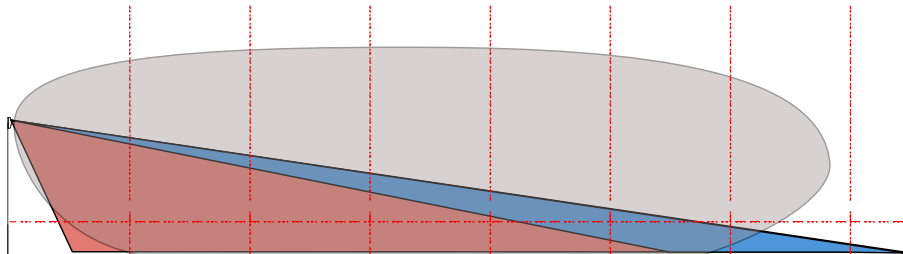
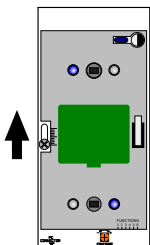
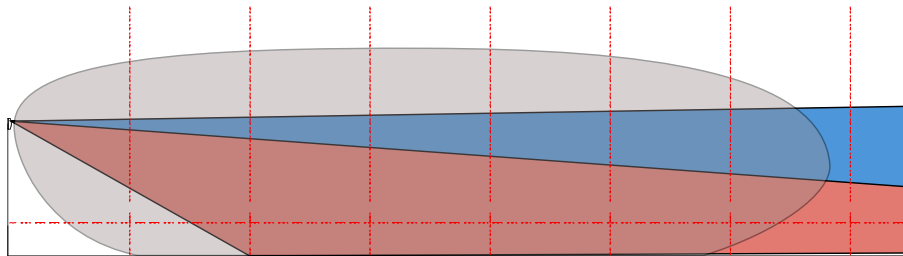
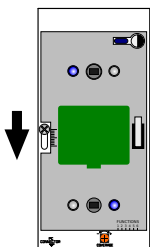
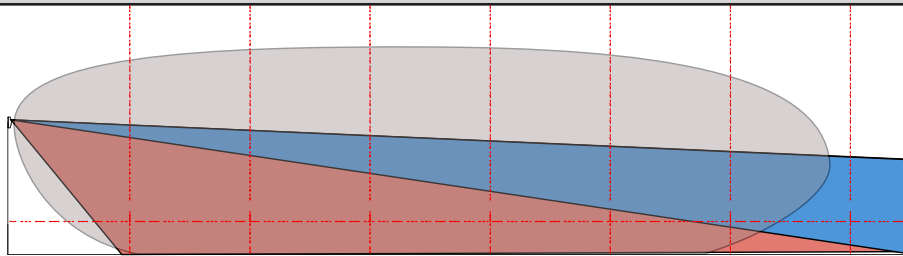
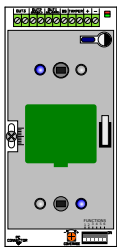

**Note:** the figures show the effect of the beams based on the position of the board. Since they are purely indicative, we recommend you thoroughly test the sensitivity of the sensor after each adjustment.

## TYPE LENS - how to recognize them

In the sensor package there are 3 types of lenses:

- Horizontal curtain lens (Fig. 1)
- Vertical curtain lens (fig. 2)
- Volumetric curtain lens (fig. 3)

On the sensors are mounted, by default, on the PIR1 (top) the volumetric lens and on the PIR2 (bottom) the horizontal curtain lens. In the next section it's explained how to use the different types of lenses.

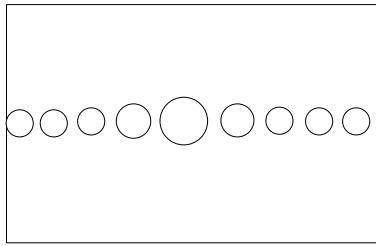

FIG. 1

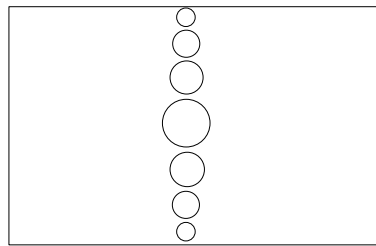
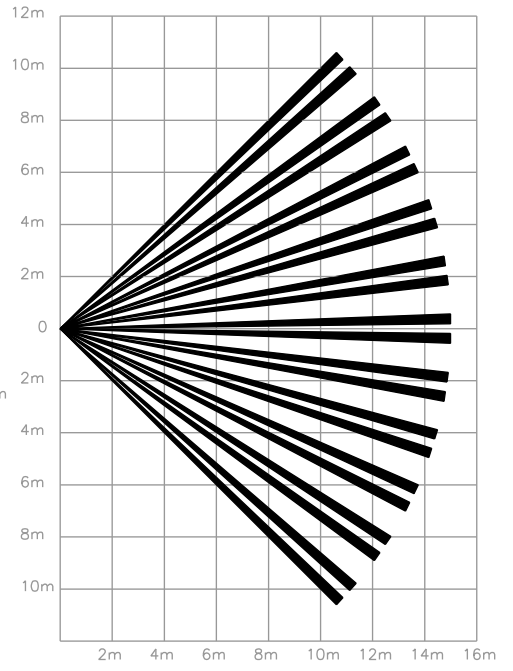
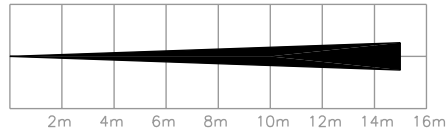

FIG. 2

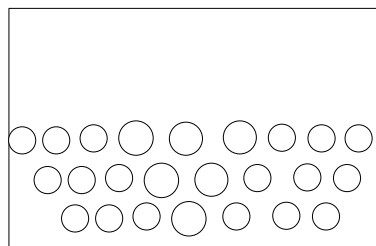
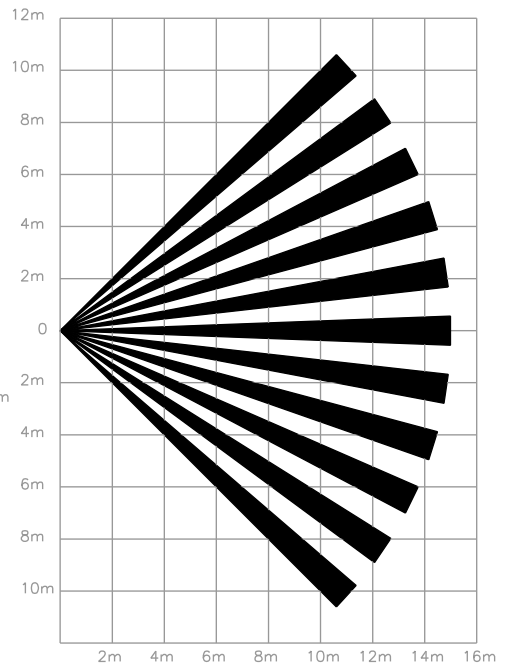
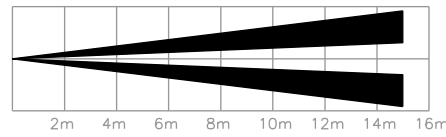
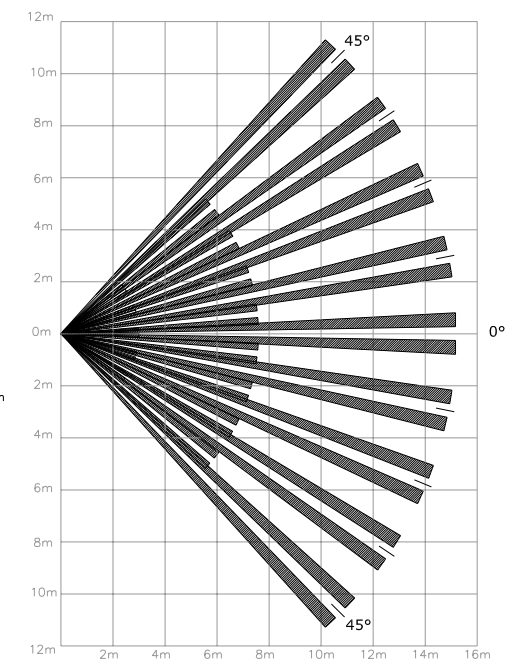
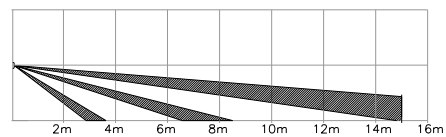

FIG. 3



## Lenses provided

The lenses mounted on the sensor are: volumetric for PIR 1 (upper), horizontal curtain for PIR 2 with rather thick beams. This solution is designed for almost all applications that require a standard installation at about 1.8/2 meters high, with the possibility of managing the presence of animals. (fig. above)

Besides the standard configuration, you can use the optional lenses included in the package.

**Using the sensor with 2 horizontal curtain lenses:** you can position the sensor at a height between 80 cm and 1.2 m based on need. Then adjust the board position based on the beam range.

This way you have a variable height protection from 35/40 cm from the ground and up to 1.6 cm high with a horizontal coverage of about 80/100 degrees. With this configuration you can achieve immunity to medium to large animals even at considerable distances (15 m).

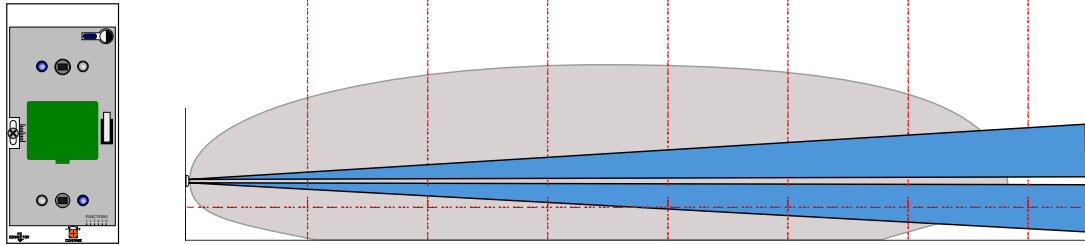

**Using the sensor with 2 vertical curtain lenses:** the use of vertical curtain lenses is based on the need to protect doors and windows with a vertical curtain that is no wider than 50 cm. In this way the protection is only near the doors and/or windows without extending into other areas. You can position the sensor at a height of between 1 m and 2 m based on need. The beam is about 50 cm wide for an aperture of about 90/100 vertical degrees (fig. below)

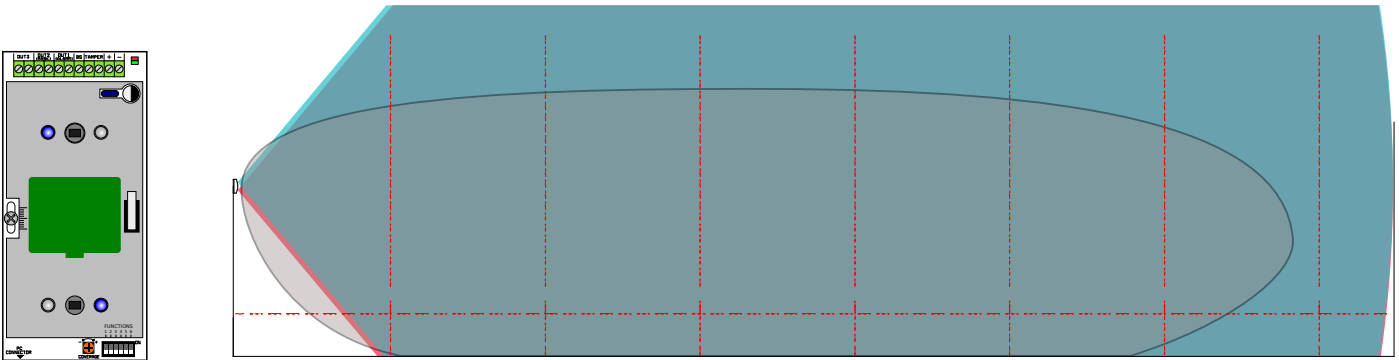

## Replacing the lenses

The lenses are attached to the sensor with funnels that are snapped into the housings on the front cover (fig.)

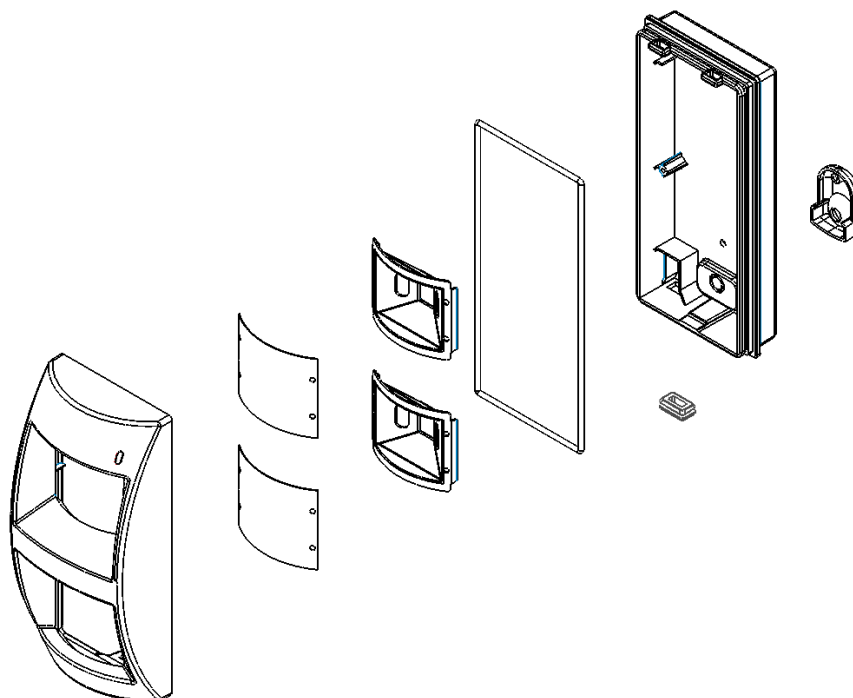

To replace the lenses you must remove the funnel and remove the lens that is resting in the housing as shown in figure 1 and 2.

**Note:** the smooth part of the lenses must be positioned towards the outside.

**Important:** the volumetric lens has one direction, therefore pay close attention to how it is positioned. When put up against the light you can see how the FRESNEL lenses work. They are always kept towards the bottom.

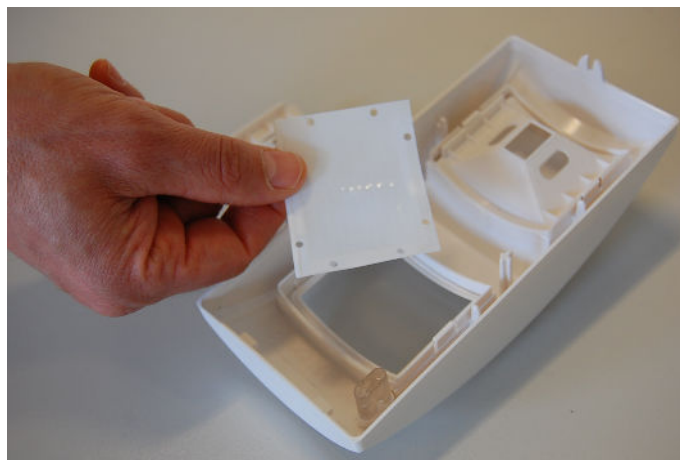

Position the new lens in the housing, replace the funnel and snap it into its housing.

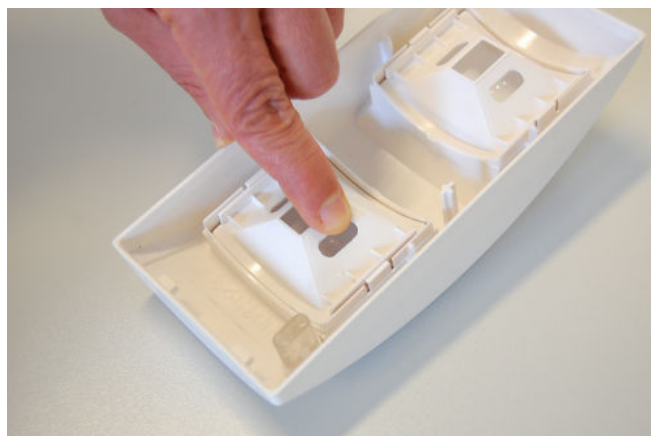

## 2. INSTALLATION

Remove the screws from the upper cover and then remove the board mounting screws.





Remove the board, making a hole in the back of the upper cover for the cable to pass through in a suitable installation position. Make another 2 holes to attach the sensor to the wall. We recommend using anchors that are no smaller than 3 mm.

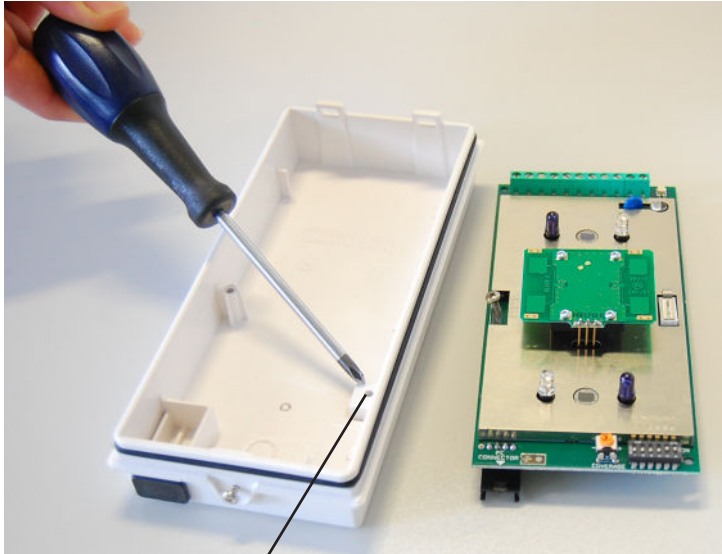

**Screw for Anti-removal system - Fig.1**

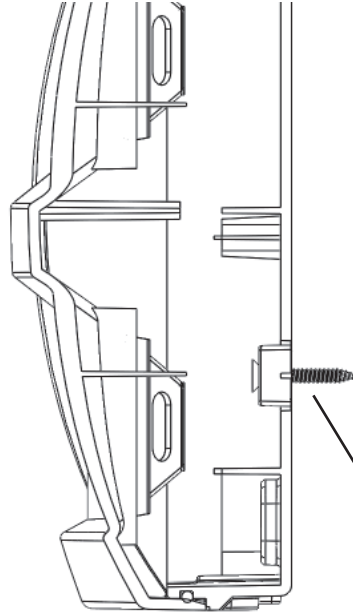

**Screw for Anti-removal system - Fig.2**

Once the cable and wall attachment holes have been made, take the measurement to attach an anchor (3 mm) to the anti-removal system. (see above fig.1 and fig.2)

Then attach the bottom and re-close, taking into account the positioning mentioned previously.

**Note:** remember that the distance between the board and the base is 13.5 mm. Space reserved for the proper positioning of the cable feeder or any piping to be inserted.

### Using the hub

You can use the hub included in the package for attaching it to the wall. The back of the cover is ready for attachment of the hub and for the passage of the cables inside it. You can see how it should be used in the figure. In case of use of the hub, for the closure of the anti-removal tamper mount the specific screw, in the seat shown in Fig. 1.

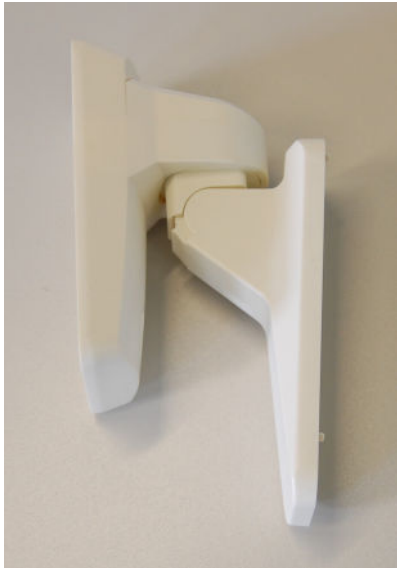

**Hub**

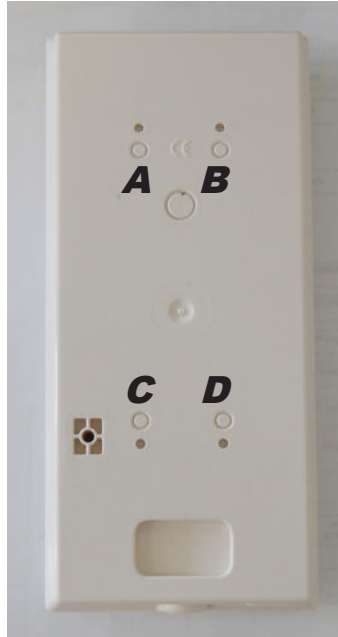

**Bottom of the detector**



**Detector + Hub**

## TECHNICAL FEATURES

<b>SOUTDOOR</b>	
<i>Input Voltage</i>	9 to 15 V $\overline{\text{---}}$
<i>Current Drain (Alarm / Stand-By)</i>	52 mA / 46 mA @ 13.8V $\overline{\text{---}}$
<i>Typical Voltage</i>	13.8V $\overline{\text{---}}$
<i>Coverage</i>	15 m
<i>Aperture Angle</i>	90°
<i>2 PIR / Pyroelectric</i>	2 PIR - 2 Elements
<i>Lens 1</i>	Fresnel (22 Patterns on 3 levels)
<i>Lens 2</i>	Fresnel horizontal curtain (11 Patterns 1 level)
<i>OPTIONAL Lens</i>	Fresnel, vertical (11 Patterns 11 level)
<i>Microwave frequency</i>	9.3 GHz / 9.9 GHz / 10.525 GHz
<i>IP grade</i>	IP 44
<i>Alarm period</i>	2 sec.
<i>Alarm Type</i>	AND - OR - AUTO OR
<i>Anti-opening</i>	✓
<i>Back Tamper</i>	✓
<i>Anti masking **</i>	✓
<i>Auto diagnosi</i>	✓
<i>OUT 1 - 2 - 3 - 4</i>	100 mA - 40 V - 2.5 - 16 $\Omega$
<i>Tamper Switch</i>	Max 40 mA - 30 Vdc
<i>Operating Temperature</i>	From -30 °C to +55 °C
<i>Storage Temperature</i>	From -30 °C to +60 °C
<i>RFI Protection</i>	30 V / m (80 / 1000 MHz)*
<i>Walk Test LED (MW and PIR)</i>	✓
<i>Housing / Cover</i>	ABS
<i>Dimensions</i>	185 X 85 X 70 mm
<i>weight</i>	275Gr

\*\* Not certified IMQ Security Systems

**Meets the requirements:**  
**Conforme ai requisiti:**

**EN 50131-2-4: 2008**  
**EN 50131-2-4 Grade 2**  
**EN 50131-2-4 Class 4**



Product compliant with Directive 99/5/EC. The declaration of conformity is available from our office.

All our products comply with the requirements in CEI 79-2 Ed. 2, 1998 + Ab 2000.

Installation must be performed according to accepted standards by specialized personnel.

The manufacturer shall not be responsible if the product is tampered with by unauthorised persons.

We recommend that you check the correct operation of the alarm system at least once per month. A reliable electronic alarm system does not prevent intrusions, robberies, fires or other occurrences but simply reduces the risk of occurrence.

This product complies with the 99/5/CE directive. The declaration of conformity is available at our offices.

Our products/systems comply with the essential requirements of EEC directives.

Installation must be carried out following the local installation norms by qualified personnel.

The manufacturer refuses any responsibility when changes or unauthorized repairs are made to the product/system.

It is recommended to test the operation of the alarm product/system at least once a month. Despite frequent testing and due to, but not limited to, any or all of the following: tampering, electrical or communication disruption or improper use, it is possible for the product/system to fail to prevent burglary, robbery, fire or otherwise. A properly installed and maintained alarm system can only reduce the risk that this happens.